

Designed to enable the Smart Factory of Tomorrow, Cleco introduces the most advanced cordless nutrunner - CellTek.™

FEATURES

- **On-Tool Storage** - Back-up on-tool data collection in the event of disrupted connection
- **Cost Savings** - Connect up to 16 tools to 1 controller
- **Flexible** - Easily connects over Wifi (2.4 & 5.0 GHz) or Bluetooth 4.0
- **Multi-Color LED** - Work light for secondary “ok/not ok” operator feedback while also illuminating your workpiece
- **Compatibility** - Forward and backward compatibility with Cleco’s entire Global cordless Controller platforms
- **Stay Alive Function** - Prevents reboot during battery change, gaining time and efficiency
- **Enhanced WiFi Range** - Up to 300 feet for a broad connection within your production facility
- **Decreased Takt Times** - Patented motor technology allows increased speeds over other battery platforms

SPECIFICATIONS

TORQUE RANGE (Nm)

Min / Max: 5.2 - 21

TORQUE RANGE (ft-lb)

Min / Max: 3.8 - 15.5

SPEED

r/min: 735

WEIGHT & DIMENSIONS

Weight w/o Battery	1.4 kg / 3.1 lb
Length	515 mm / 20.28 in
Height	38.7 mm / 1.52 in
Side to Center	14.3mm / 0.56 in
Output	3/8” Square Drive
Country of Origin:	Assembled in USA

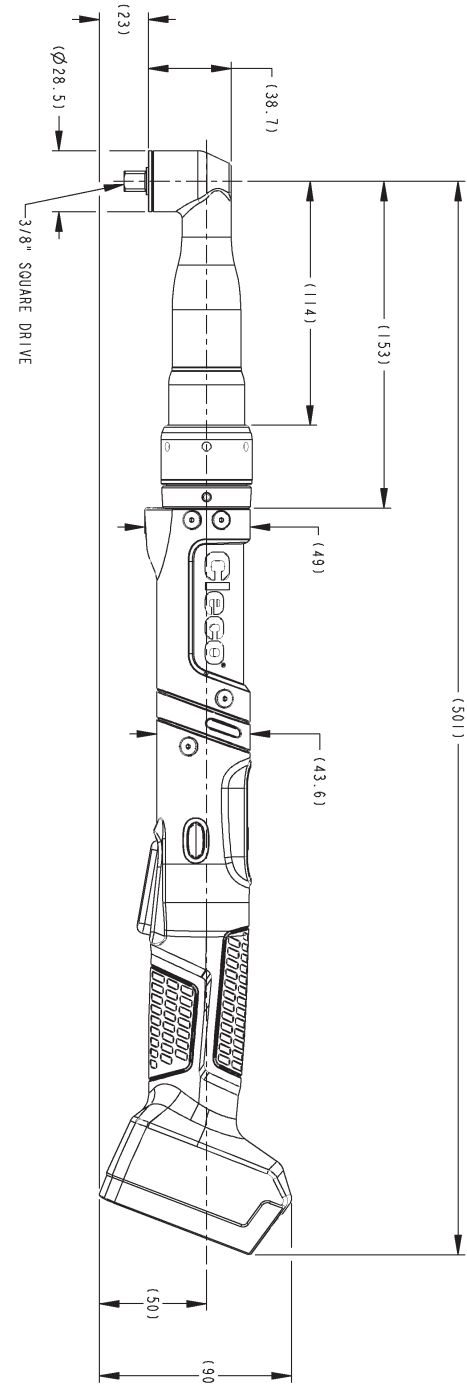

Apex Tool Group, LLC

Phone: +1 (800) 845-5629

Phone: +1 (919) 387-0099

Phone: +49 (0)7363 81-0

www.ClecoTools.com / www.ClecoTools.de